



QUICK SELECTION / Selezione veloce

input speed (n_1) = 1400 min⁻¹

Output Speed n_2 [min ⁻¹]	Ratio i	Motor power P_{1M} [kW]	Output torque M_{2M} [Nm]	Service factor f.s.	Nominal power P_{1R} [kW]	Nominal torque M_{2R} [Nm]	Available B5 motor flanges					Available B14 motor flanges				Dynamic efficiency RD	Tooth Module [mm]	Ratios code	
							-C	-D	-E	-F	-G	-R	-T	-U	-V				
							71	80	90	100 112	132	80	90	100 112	132				
200	7	7.5	315	1.5	11.5	483		B	B				B	B			88	5.5	01
140	10	7.5	440	1.2	9.0	525		B	B				B	B			86	5.4	02
88	16	5.5	492	1.1	6.0	536		B	B				B	B			82	5.3	03
70	20	4.0	447	1.2	4.9	546		B	B				B	B			82	4.5	04
61	23	3.0	377	1.4	4.1	515		B	B				B	B			80	3.9	05
47	30	3.0	467	1.4	4.2	651		B	B				B	B			76	5.6	06
37	38	3.0	583	1.1	3.3	641		B	B				B	B			75	4.7	07
31	45	2.2	493	1.2	2.7	599		B	B				B	B			73	4.0	08
26	53	2.2	557	1.1	2.5	620		B	B				B	B			70	3.5	09
22	64	1.5	452	1.2	1.8	536	B	B					B				69	2.9	10
16.7	84	1.1	410	1.2	1.3	494	B	B					B				65	2.2	11
14.1	99	1.1	446	1.1	1.2	483	B	B					B				60	1.9	12

 Motor Flanges Available Flange Motore Disponibili
B Supplied with Reduction Bushing Fornito con Bussola di Riduzione
B Available on Request without reduction bushing Disponibile a Richiesta senza Bussola di Riduzione
C Motor Flange Holes Position Posizione Fori Flangia Motore

EN Unit 110 is supplied without lubricant and equipped with a breather, level and drain plugs. User can add mineral oil keeping existing plugs. Should the user wish to fill it with synthetic oil, it is recommended to replace the existing plugs with a closed plug. See table 1 for lubrication and recommended quantity. In table 2 please see possible radial loads and axial loads on the gearbox.

I Il riduttore tipo 110 è fornito privo di lubrificazione con tappi di sfiato, livello e scarico olio. L'utente può immettere olio minerale mantenendo i tappi esistenti. Se immetterà olio sintetico, dovrà sostituire i tappi esistenti con altri tipo chiuso. Tab.1 per oli e quantità consigliati. Tab.2 carichi radiali e assiali applicabili al riduttore.

D Das Getriebe der Baugröße 110 wird ohne Schmiermittel geliefert. Es ist jedoch mit Einfüllschraube, Überdruckventil und Ablassschraube ausgerüstet. Das benötigte mineralische Öl kann über die Einfüllschraube eingefüllt werden. Sollte synthetisches Öl bevorzugt werden, so ist sind das eingebaute Überdruckventil durch eine geschlossenen Schraube zu ersetzen. In Tabelle 1 ist die Schmiermenge und das empfohlene Schmiermittel angegeben. In Tabelle 2 sind die zulässigen Radial - und Axialbelastungen des Getriebes aufgeführt.

F Le réducteur de type 110 est fourni sans lubrification et avec un bouchon de remplissage, de niveau et d'évacuation de l'huile. L'utilisateur peut y verser de l'huile minérale en conservant les bouchons existants. S'il y versera de l'huile synthétique, il devra substituer les bouchons existants avec d'autres bouchons de type fermé. Voir tableau 1 concernant les huiles et les quantités conseillées. Voir tableau 2 concernant les charges radiales et axiales applicables au réducteur.

E El reductor tamaño 110 se suministra sin lubricante, provisto de tapones de respiración, nivel y descarga de aceite. El usuario puede utilizar aceite mineral, manteniendo los tapones existentes. Si prefiere utilizar aceite sintético deberá sustituir los tapones existentes por tapones ciegos. La prerreducción se suministra con tapones ciegos, lubricado de por vida con aceite sintético. Ver tabla 1, para cantidades y aceites recomendados. En la tabla 2, se encuentran las cargas radiales y axiales admitidas por el reductor.

B3	B6	B7	B8	V5	V6
1.90 LT	1.35 LT	1.35 LT	2.00LT	2.00 LT	2.00LT

AGIP Blasias 460

For all details on lubrication and plugs check our website [tab. 1](#)
Per maggiori dettagli su lubrificazione e tappi olio vedi il nostro sito web

RADIAL AND AXIAL LOADS

Output shaft
Albero di uscita

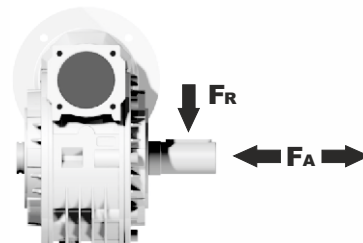

n_2 [min ⁻¹]	FA [N]	FR [N]
200	600	2900
150	700	3300
100	750	3600
75	800	4000
50	920	4600
25	1200	6000
15	1400	7000

Input shaft
albero in entrata

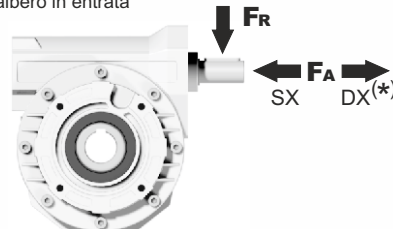

n_1 [min ⁻¹]	FA [N]	FR [N]
1400	228	1140

***Strong axial loads in the DX direction are not allowed.**
Non sono consentiti forti carichi assiali con direzione DX

tab. 2

P110FB... Basic wormbox
Riduttore base

Gearbox weight
peso riduttore **35.00 kg**

M. flanges	Kit code	øF	A
71B5	K023.4.041	160	136
80/90B5	K023.4.042	200	138
100/112B5	K023.4.043	250	147
132B5	-	300	187
80B14	K085.4.046	120	138
90B14	K085.4.045	140	138
100/112B14	K023.4.041	160	136
132B14	-	200	187

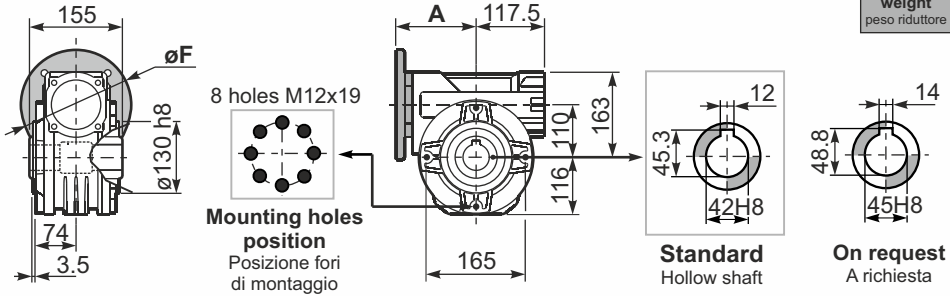

P110PA... Feet
Piedini

P110PB... Feet
Piedini

P110PV... Feet
Piedini

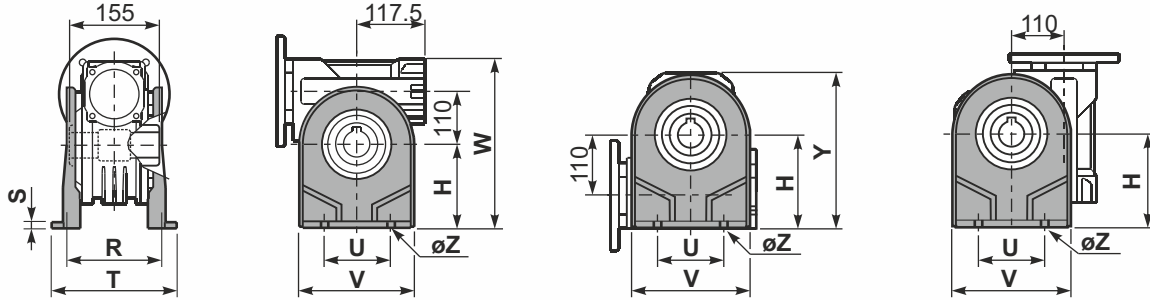

	H	R	S	T	U	V	Y	W	øZ	kit code
type B	170	180	22	224	200	240	286	333	ø13	K110.9.022
type S	172	160	8	204	200	240	288	335	ø14	KS110.9.023

P110FC... Output flange
Flangia uscita

P110BR... Reaction arm
Braccio di reazione

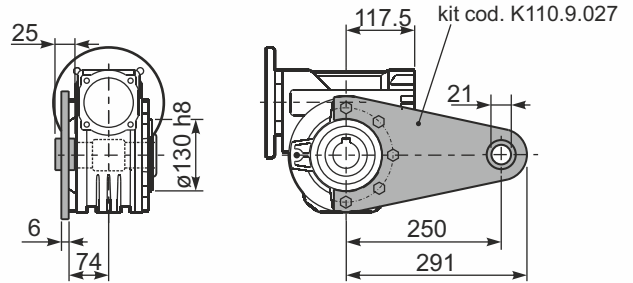
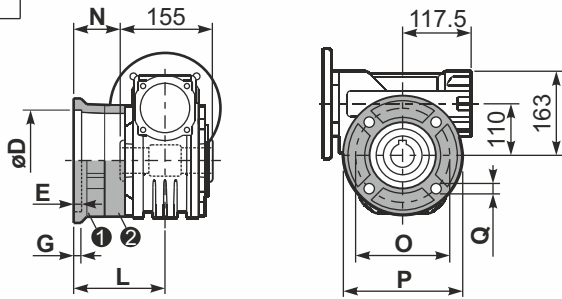

type B	øD	E	G	L	N	O	P	Q	kit code
FC	170 ^{+0.083} / _{+0.043}	11	16.5	131.5	54	230	270	13	① K110.9.010 ② -
FL	170 ^{+0.083} / _{+0.043}	11	16.5	179.5	102	230	270	13	① K110.9.011 ② -
type S	øD	E	G	L	N	O	P	Q	kit code
F1	180 ^{+0.040} / ₀	5	18	150	72.5	215	250	15	① KS110.9.014 ② -
F2	170 ^{+0.083} / _{+0.043}	9.5	15	178	100.5	230	270	13	① KS110.9.012 ② -
F3	180 ^{+0.040} / ₀	5	18	130	52.5	215	250	15	① KS110.9.013 ② -

P110.....S... Single Shaft
Albero lento semplice

P110.....D... Double Shaft
Albero lento bisp.

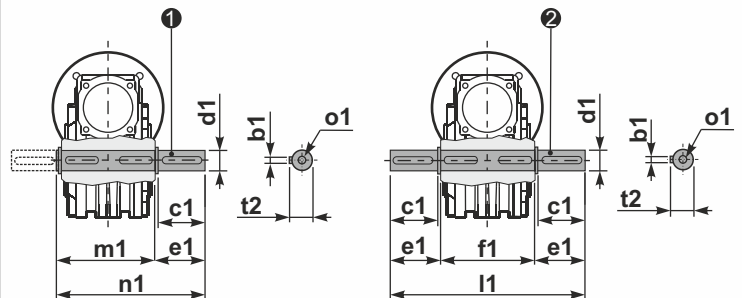

① kit cod. K110.5.028 type B

② kit cod. K110.5.029 type B

R110FB... Input shaft
Albero in entrata

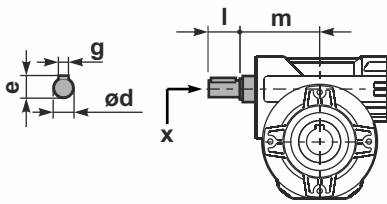

	ød	e	g	l	m	x	kit code
type B	25 h6	28	8	50	131.5	M8x20	① K085.5.007 PAM90 ② K085.5.008 PAM100
type S	24 h6	27	8	50	131.5	M8x20	① KS085.5.009 PAM90 ② KS085.5.011 PAM100

	b1	c1	d1	e1	f1	l1	m1	n1	t2	o1
type B	12	75	42 ^{-0.005} / _{-0.020}	96.5	155	348	163.5	260	45	M12x32
type S	-	-	-	-	-	-	-	-	-	-